

Biliary Access

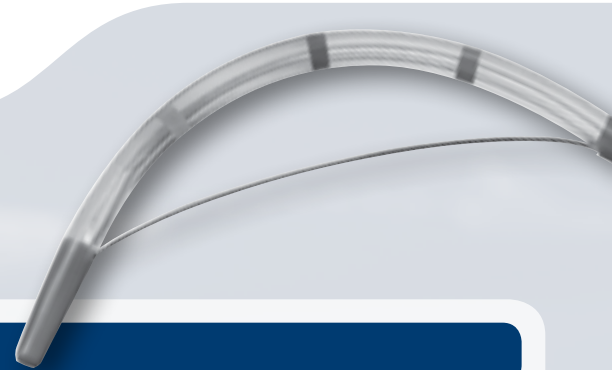

Biliary Access

Guidewires

- Dreamwire™ High Performance Guidewire1
- Hydra Jagwire™ High Performance Guidewire1
- Jagtail™ Guidewire Extension 2
- Jagwire™ High Performance Guidewire 2
- NaviPro™ Hydrophilic Guidewire 3
- NovaGold™ High Performance Guidewire 3

RX Preloaded Sphincterotomes

- Dreamtome™ RX Cannulating Sphincterotome
(Preloaded with Dreamwire High Performance Guidewire) 4
- Hydratome™ RX Cannulating Sphincterotome
(Preloaded with Hydra Jagwire High Performance Guidewire) 4
- Jagtome™ RX Cannulating Sphincterotome
(Preloaded with Jagwire High Performance Guidewire) 5

RX Sphincterotomes

- Autotome™ RX Cannulating Sphincterotome 6
- RX Cholangiogram Kits 6
- RX Needle Knife XL Triple-Lumen Needle Knife 6

Preloaded Sphincterotomes

- TRUetome™ Jag Cannulating Sphincterotome
(Preloaded with Jagwire High Performance Guidewire) 7
- TRUetome Hydra Cannulating Sphincterotome
(Preloaded with Hydra Jagwire High Performance Guidewire) 7
- TRUetome Dreamwire Cannulating Sphincterotome
(Preloaded with Dreamwire High Performance Guidewire) 7

Sphincterotomes

- MicroKnife™ XL Triple-Lumen Needle Knife 8
- Stonetome™ Stone Removal Device 9
- TRUetome Cannulating Sphincterotome 8
- Ultratome™ Double-Lumen Sphincterotome 10
- Ultratome XL Triple-Lumen Sphincterotome 9

RX Cannulas

- Rapid Exchange XL Cannula 10
- RX ERCP Cannulas 10

Cannulas

- Contour™ ERCP Cannulas 11
- Tandem™ XL Triple-Lumen ERCP Cannula 11

Accessories

- Active Cords
(Fits Boston Scientific Endoscopy Sphincterotome) 12
- RX Locking Devices and Biopsy Cap Systems 12

Rapid Refill Continuous Injection System

- Rapid Refill Continuous Injection System 12



Biliary

Guidewires

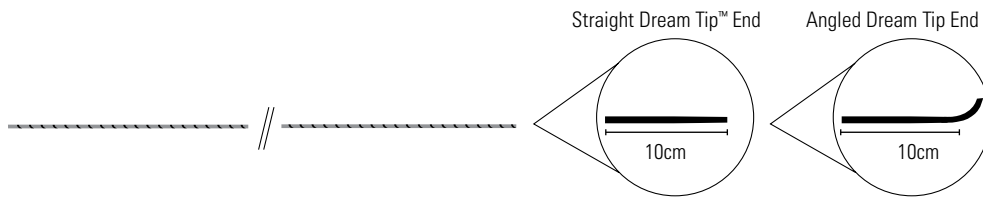

Dreamwire™ High Performance Guidewire



Order Number	GTIN	Description	Distal Tip O.D. (in)	Working Length (cm)	Shaft Style	Dream Tip Style	Tip	Packaging
M00556101	08714729777816	Dreamwire Guidewire ST	.035	260	Standard	Straight	Round	Box 2
M00556111	08714729777847	Dreamwire Guidewire ANG	.035	260	Standard	Angled	Round	Box 2
M00556121	08714729777830	Dreamwire Guidewire ST Stiff	.035	260	Stiff	Straight	Round	Box 2
M00556131	08714729777823	Dreamwire Guidewire ANG Stiff	.035	260	Stiff	Angled	Round	Box 2
M00556141	08714729777885	Dreamwire Guidewire ST	.035	450	Standard	Straight	Round	Box 2
M00556151	08714729777878	Dreamwire Guidewire ANG	.035	450	Standard	Angled	Round	Box 2
M00556161	08714729777861	Dreamwire Guidewire ST Stiff	.035	450	Stiff	Straight	Round	Box 2
M00556171	08714729777854	Dreamwire Guidewire ANG Stiff	.035	450	Stiff	Angled	Round	Box 2

ST = Straight, ANG = Angled

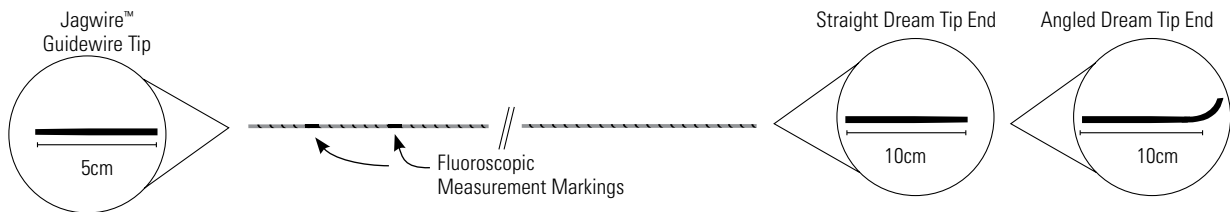

Hydra Jagwire™ High Performance Guidewire



Order Number	GTIN	Description	Distal Tip O.D. (in)	Working Length (cm)	Shaft Style	Dream Tip Style	Tip	Packaging
M00556001	08714729648437	Hydra Jagwire Guidewire ST	.035	260	Standard	Straight	Round	Box 2
M00556011	08714729648444	Hydra Jagwire Guidewire ANG	.035	260	Standard	Angled	Round	Box 2
M00556021	08714729648451	Hydra Jagwire Guidewire ST Stiff	.035	260	Stiff	Straight	Round	Box 2
M00556031	08714729648468	Hydra Jagwire Guidewire ANG Stiff	.035	260	Stiff	Angled	Round	Box 2
M00556041	08714729648475	Hydra Jagwire Guidewire ST	.035	450	Standard	Straight	Round	Box 2
M00556051	08714729648482	Hydra Jagwire Guidewire ANG	.035	450	Standard	Angled	Round	Box 2
M00556061	08714729648499	Hydra Jagwire Guidewire ST Stiff	.035	450	Stiff	Straight	Round	Box 2
M00556071	08714729648505	Hydra Jagwire Guidewire ANG Stiff	.035	450	Stiff	Angled	Round	Box 2

Hydra Jagwire Guidewire may remain in place during sphincterotomy. See Instructions for Use for details.

ST = Straight, ANG = Angled

Biliary

Guidewires (Continued)

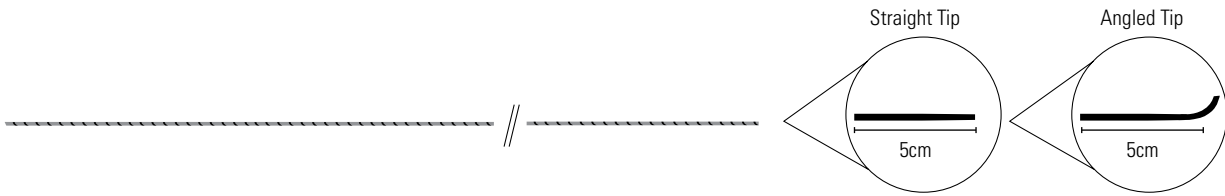

Jagwire™ High Performance Guidewire



Order Number	GTIN	Description	Distal Tip O.D. (in)	Working Length (cm)	Shaft Style	Tip Style	Tip	Packaging
M00556511	08714729874492	Jagwire Guidewire ANG	.025	450	Standard	Angled	Round	Box 2
M00556521	08714729874508	Jagwire Guidewire ST Stiff	.025	450	Stiff	Straight	Round	Box 2
M00556531	08714729874515	Jagwire Guidewire ANG Stiff	.025	450	Stiff	Angled	Round	Box 2
M00556561	08714729501374	Jagwire Guidewire ST	.025	450	Standard	Straight	Trim	Box 2
M00556581	08714729339151	Jagwire Guidewire ST	.035	450	Standard	Straight	Trim	Box 2
M00556591	08714729501398	Jagwire Guidewire ANG	.035	450	Standard	Angled	Trim	Box 2
M00556601	08714729172154	Jagwire Guidewire ST Stiff	.035	450	Stiff	Straight	Trim	Box 2
M00556611	08714729172161	Jagwire Guidewire ANG Stiff	.035	450	Stiff	Angled	Trim	Box 2
M00556621	08714729172178	Jagwire Guidewire ST	.038	260	Standard	Straight	Trim	Box 2
M00556631	08714729172185	Jagwire Guidewire ST Stiff	.035	260	Stiff	Straight	Trim	Box 2
M00556641	08714729172192	Jagwire Guidewire ST	.035	260	Standard	Straight	Trim	Box 2
M00556651	08714729172208	Jagwire Guidewire ANG	.035	260	Standard	Angled	Trim	Box 2
M00556661	08714729172215	Jagwire Guidewire ANG Stiff	.035	260	Stiff	Angled	Trim	Box 2
M00556461	08714729415183	Jagwire Guidewire ST	.025	260	Standard	Straight	Round	Box 2
M00556481	08714729415190	Jagwire Guidewire ST Stiff	.025	260	Stiff	Straight	Round	Box 2
M00556491	08714729415206	Jagwire Guidewire ANG Stiff	.025	260	Stiff	Angled	Round	Box 2
M00556841	08714729268680	Extendable Jagwire Guidewire ST	.035	260	Standard	Straight	Round	Box 2
M00556851	08714729268697	Extendable Jagwire Guidewire ANG	.035	260	Standard	Angled	Round	Box 2
M00556861	08714729268703	Extendable Jagwire Guidewire ST Stiff	.035	260	Stiff	Straight	Round	Box 2
M00556871	08714729268710	Extendable Jagwire Guidewire ANG Stiff	.035	260	Stiff	Angled	Round	Box 2
M00556902	08714729268734	Jagtail™ Guidewire Extension	.035	200	–	Guidewire extension	–	Box 5

Jagwire Guidewire may remain in place during sphincterotomy. See Instructions for Use for details.
ST = Straight, ANG = Angled

Biliary

Guidewires (Continued)

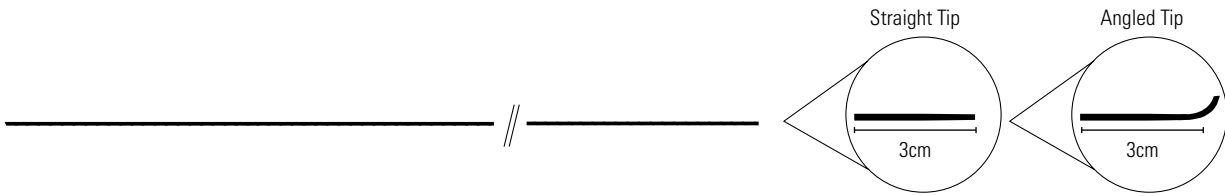

NaviPro™ Hydrophilic Guidewire



Order Number	GTIN	Description	Guidewire Diameter (in)	Length (cm)	Shaft Style	Tip Style	Packaging
M00556191	08714729839873	NaviPro Hydrophilic Guidewire	0.018	260	Standard	Angled	Box 5
M00556181	08714729839866	NaviPro Hydrophilic Guidewire	0.018	260	Standard	Straight	Box 5
M00556211	08714729839897	NaviPro Hydrophilic Guidewire	0.025	260	Standard	Angled	Box 5
M00556201	08714729839880	NaviPro Hydrophilic Guidewire	0.025	260	Standard	Straight	Box 5
M00556231	08714729839910	NaviPro Hydrophilic Guidewire	0.035	260	Standard	Angled	Box 5
M00556221	08714729839903	NaviPro Hydrophilic Guidewire	0.035	260	Standard	Straight	Box 5
M00556251	08714729839934	NaviPro Hydrophilic Guidewire	0.035	260	Stiff	Angled	Box 5
M00556241	08714729839927	NaviPro Hydrophilic Guidewire	0.035	260	Stiff	Straight	Box 5

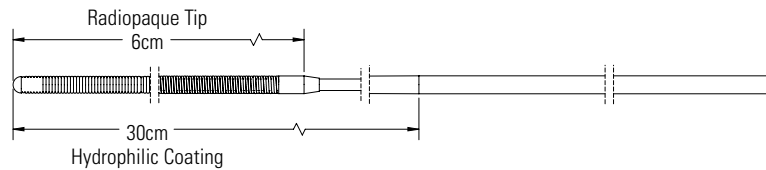

NovaGold™ High Performance Guidewire



Order Number	GTIN	Description	Distal Tip O.D. (in)	Working Length (cm)	Tip Style	Tip Length (cm)	Packaging
M00552001	08714729854418	NovaGold High Performance Guidewire	.018	260	Straight (shapeable)	6	Box 2
M00552011	08714729854425	NovaGold High Performance Guidewire	.018	480	Straight (shapeable)	6	Box 2

Biliary

RX Preloaded Sphincterotomes

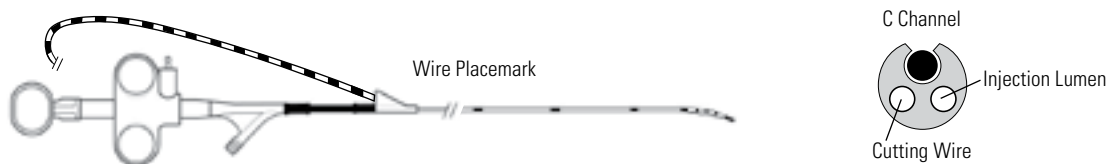

Dreamtome™ RX Cannulating Sphincterotome (Preloaded with Dreamwire™ High Performance Guidewire)

Order Number	GTIN	Description	Tip Length (mm)	Cut Wire Length (mm)	Preloaded Guidewire (in / cm)	Guidewire Tip Style	Packaging
M00584000	08714729778226	Dreamtome RX 49 Sphincterotome	5	20	.035 / 260 Dreamwire Guidewire	Straight	Each
M00584010	08714729778233	Dreamtome RX 49 Sphincterotome	5	30	.035 / 260 Dreamwire Guidewire	Straight	Each
M00584020	08714729778240	Dreamtome RX 49 Sphincterotome	5	20	.035 / 450 Dreamwire Guidewire	Straight	Each
M00584030	08714729778257	Dreamtome RX 49 Sphincterotome	5	30	.035 / 450 Dreamwire Guidewire	Straight	Each
M00584040	08714729778264	Dreamtome RX 44 Sphincterotome	5	20	.035 / 260 Dreamwire Guidewire	Straight	Each
M00584050	08714729778271	Dreamtome RX 44 Sphincterotome	5	30	.035 / 260 Dreamwire Guidewire	Straight	Each
M00584060	08714729778288	Dreamtome RX 44 Sphincterotome	5	20	.035 / 450 Dreamwire Guidewire	Straight	Each
M00584070	08714729778295	Dreamtome RX 44 Sphincterotome	5	30	.035 / 450 Dreamwire Guidewire	Straight	Each

*Preloaded with straight-tip guidewires only.
Active Cords sold separately (See page 12).

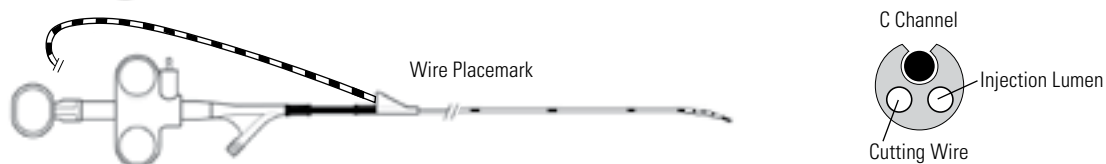

Hydratome™ RX Cannulating Sphincterotome (Preloaded with Hydra Jagwire™ High Performance Guidewire)

Order Number	GTIN	Description	Cut Wire (mm)	Tip Length (mm)	Distal Tip O.D. (Fr)	Preloaded Guidewire (cm)	Guidewire Tip Style	Packaging
M00583000	08714729755159	Hydratome RX 49 Sphincterotome	20	5	4.9	260 Hydra Jagwire Guidewire	Straight	Each
M00583010	08714729755166	Hydratome RX 49 Sphincterotome	30	5	4.9	260 Hydra Jagwire Guidewire	Straight	Each
M00583020	08714729755173	Hydratome RX 49 Sphincterotome	20	5	4.9	450 Hydra Jagwire Guidewire	Straight	Each
M00583030	08714729755180	Hydratome RX 49 Sphincterotome	30	5	4.9	450 Hydra Jagwire Guidewire	Straight	Each
M00583040	08714729755197	Hydratome RX 44 Sphincterotome	20	5	4.4	260 Hydra Jagwire Guidewire	Straight	Each
M00583050	08714729755203	Hydratome RX 44 Sphincterotome	30	5	4.4	260 Hydra Jagwire Guidewire	Straight	Each
M00583060	08714729755210	Hydratome RX 44 Sphincterotome	20	5	4.4	450 Hydra Jagwire Guidewire	Straight	Each
M00583070	08714729755227	Hydratome RX 44 Sphincterotome	30	5	4.4	450 Hydra Jagwire Guidewire	Straight	Each

Active Cords sold separately (See page 12).

Biliary

RX Preloaded Sphincterotomes (Continued)

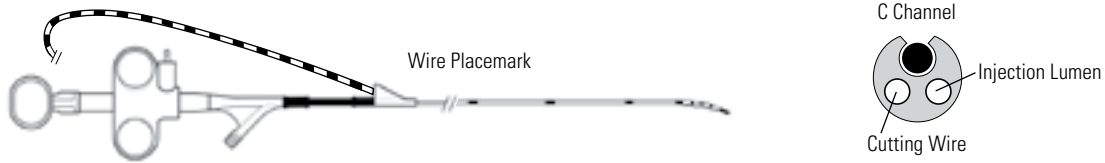

Jagtome™ RX Cannulating Sphincterotome (Preloaded with Jagwire™ High Performance Guidewire)



Order Number	GTIN	Description	Cut Wire (mm)	Tip Length (mm)	Distal Tip O.D. (Fr)	Preloaded Guidewire (in / cm)	Guidewire Tip Style	Packaging
M00573000	08714729776710	Jagtome RX 49 Sphincterotome	20	5	4.9	.035 / 260 Jagwire Guidewire	Straight	Each
M00573010	08714729776727	Jagtome RX 49 Sphincterotome	20	5	4.9	.035 / 450 Jagwire Guidewire	Straight	Each
M00573020	08714729776734	Jagtome RX 49 Sphincterotome	30	5	4.9	.035 / 260 Jagwire Guidewire	Straight	Each
M00573030	08714729776741	Jagtome RX 49 Sphincterotome	30	5	4.9	.035 / 450 Jagwire Guidewire	Straight	Each
M00573040	08714729776659	Jagtome RX 44 Sphincterotome	20	5	4.4	.035 / 260 Jagwire Guidewire	Straight	Each
M00573050	08714729776666	Jagtome RX 44 Sphincterotome	20	5	4.4	.035 / 450 Jagwire Guidewire	Straight	Each
M00573060	08714729776673	Jagtome RX 44 Sphincterotome	30	5	4.4	.035 / 260 Jagwire Guidewire	Straight	Each
M00573070	08714729776543	Jagtome RX 44 Sphincterotome	30	5	4.4	.035 / 450 Jagwire Guidewire	Straight	Each
M00573080	08714729776642	Jagtome RX 39 Sphincterotome	20	5	3.9	.025 / 260 Jagwire Guidewire	Straight	Each
M00573090	08714729776550	Jagtome RX 39 Sphincterotome	20	5	3.9	.025 / 450 Jagwire Guidewire	Straight	Each
M00573100	08714729776536	Jagtome RX 39 Sphincterotome	30	5	3.9	.025 / 260 Jagwire Guidewire	Straight	Each
M00573110	08714729776529	Jagtome RX 39 Sphincterotome	30	5	3.9	.025 / 450 Jagwire Guidewire	Straight	Each

Active Cords sold separately (See page 12).

Biliary

RX Sphincterotomes

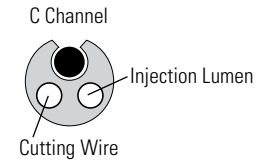

Autotome™ RX Cannulating Sphincterotome



Order Number	GTIN	Description	Cut Wire (mm)	Tip Length (mm)	Distal Tip O.D. (Fr)	Recommended Guidewire (in)	Packaging
M00545150	08714729415138	Autotome RX 49 Cannulating Sphincterotome	20	5	4.9	.035	Each
M00545160	08714729415152	Autotome RX 49 Cannulating Sphincterotome	30	5	4.9	.035	Each
M00545170	08714729444749	Autotome RX 44 Cannulating Sphincterotome	20	5	4.4	.035	Each
M00545180	08714729444756	Autotome RX 44 Cannulating Sphincterotome	30	5	4.4	.035	Each
M00545190	08714729444763	Autotome RX 39 Cannulating Sphincterotome	20	5	3.9	.025	Each
M00545200	08714729444770	Autotome RX 39 Cannulating Sphincterotome	30	5	3.9	.025	Each

Active Cords sold separately [▶](#) (See page 12).

RX Cholangiogram Kits*



Order Number	Description	Sphincterotome	Guidewire	Accessory
M005XXXX1	Cholangiogram Kit	Autotome or Ultratome XL Sphincterotome	Jagwire™ Guidewire	N / A
M005XXXX1	Cholangiogram Kit-Preloaded	Autotome Sphincterotome	Jagwire Guidewire	RX Locking Device

*To order RX Cholangiogram Kits please contact your local Boston Scientific Endoscopy Sales Representative.



RX Needle Knife XL Triple-Lumen Needle Knife



Order Number	GTIN	Description	Length (cm)	Cut Wire (mm)	Distal Tip O.D. (Fr)	Recommended Guidewire (in)	Packaging
M00545840	08714729283799	RX Needle Knife	200	5	5.5	.035	Each

Biliary

Preloaded Sphincterotomes

TRUEtome™ Jag Cannulating Sphincterotome (Preloaded with Jagwire™ High Performance Guidewire) 							
Order Number	GTIN	Description	Tip Length (mm)	Cut Wire Length (mm)	Preloaded Guidewire (in / cm)	Tip O.D. (Fr)	Packaging
M00583080	08714729858621	TRUEtome 39 Sphincterotome	5	20	.025 / 450 Jagwire Guidewire	3.9	Each
M00583090	08714729858638	TRUEtome 44 Sphincterotome	5	20	.025 / 450 Jagwire Guidewire	4.4	Each
M00583100	08714729858645	TRUEtome 44 Sphincterotome	5	20	.035 / 450 Jagwire Guidewire	4.4	Each
M00583110	08714729858652	TRUEtome 44 Sphincterotome	5	20	.035 / Stiff 450 Jagwire Guidewire	4.4	Each
M00583120	08714729858669	TRUEtome 39 Sphincterotome	5	30	.025 / 450 Jagwire Guidewire	3.9	Each
M00583130	08714729858676	TRUEtome 44 Sphincterotome	5	30	.025 / 450 Jagwire Guidewire	4.4	Each
M00583140	08714729858683	TRUEtome 44 Sphincterotome	5	30	.035 / 450 Jagwire Guidewire	4.4	Each
M00583150	08714729858690	TRUEtome 44 Sphincterotome	5	30	.035 / Stiff 450 Jagwire Guidewire	4.4	Each
TRUEtome Hydra Cannulating Sphincterotome (Preloaded with Hydra Jagwire™ High Performance Guidewire) 							
M00583160	08714729858706	TRUEtome 44 Sphincterotome	5	20	.035 / 450 Hydra Jagwire Guidewire	4.4	Each
M00583170	08714729858713	TRUEtome 44 Sphincterotome	5	30	.035 / 450 Hydra Jagwire Guidewire	4.4	Each
TRUEtome Dreamwire™ Cannulating Sphincterotome (Preloaded with Dreamwire High Performance Guidewire) 							
M00583180	08714729858720	TRUEtome 44 Sphincterotome	5	20	.035 / 260 Dreamwire Guidewire	4.4	Each
M00583190	08714729858737	TRUEtome 44 Sphincterotome	5	20	.035 / 450 Dreamwire Guidewire	4.4	Each
M00583200	08714729858744	TRUEtome 44 Sphincterotome	5	30	.035 / 260 Dreamwire Guidewire	4.4	Each
M00583210	08714729858751	TRUEtome 44 Sphincterotome	5	30	.035 / 450 Dreamwire Guidewire	4.4	Each

*Preloaded with straight-tip guidewires only.
Active Cords sold separately  (See page 12).

Biliary

Sphincterotomes

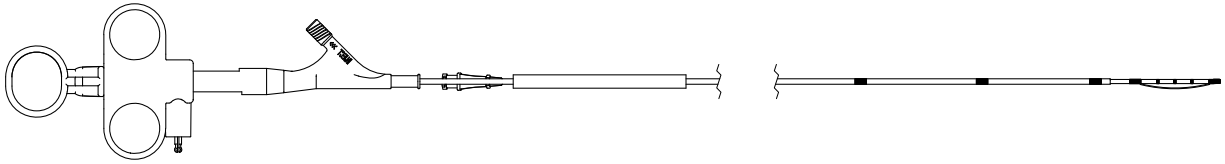

TRUEtome™ Cannulating Sphincterotome



Order Number	GTIN	Description	Cut Wire Length (mm)	Tip Length (mm)	Distal Tip O.D. (Fr)	Recommended Guidewire (in)	Packaging
M00584190	08714729827658	TRUEtome 39 Sphincterotome	20	5	3.9	.025	Each
M00584120	08714729827771	TRUEtome 39 Sphincterotome	30	5	3.9	.025	Each
M00584170	08714729827634	TRUEtome 44 Sphincterotome	20	5	4.4	.035	Each
M00584180	08714729827641	TRUEtome 44 Sphincterotome	30	5	4.4	.035	Each
M00584150	08714729827610	TRUEtome 49 Sphincterotome	20	5	4.9	.035	Each
M00584160	08714729827627	TRUEtome 49 Sphincterotome	30	5	4.9	.035	Each

Active Cords sold separately [▶](#) (See page 12).

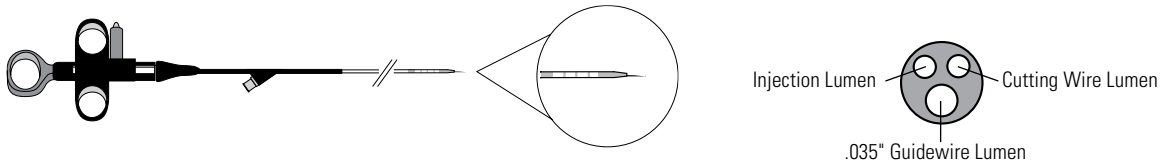

MicroKnife™ XL Triple-Lumen Needle Knife



Order Number	GTIN	Description	Shaft O.D. (Fr)	Catheter Length (cm)	Recommended Guidewire (in)	Packaging
M00532810	08714729172017	MicroKnife XL Triple-Lumen Needle Knife	7.0 - 5.5	200	.035	Each

Active Cords sold separately [▶](#) (See page 12).

Biliary

Sphincterotomes (Continued)

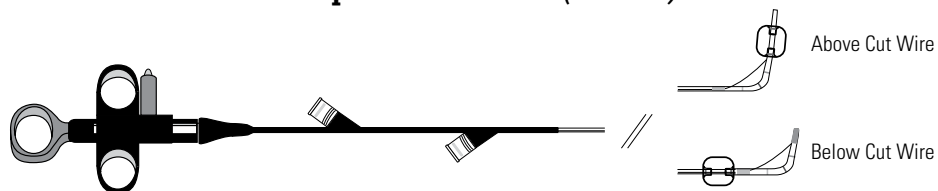

Stonetome™ Stone Removal Device



Order Number	GTIN	Description	Balloon Diameter (mm)	Catheter Length (cm)	Tip Length (mm)	Cut Wire (mm)	Distal Tip O.D. (Fr)	Recommended Guidewire (in)	Packaging
M00535150	08714729146667	Stonetome Device (below cut wire)	11.5	200	5	20	5.5	.035	Each
M00535170	08714729146629	Stonetome Device (below cut wire)	11.5	200	20	20	5.5	.035	Each
M00535190	08714729146612	Stonetome Device (below cut wire)	11.5	200	5	30	5.5	.035	Each
M00535210	08714729146605	Stonetome Device (below cut wire)	11.5	200	20	30	5.5	.035	Each
M00535110	08714729146599	Stonetome Device (above cut wire)	11.5	200	20	20	5.5	.035	Each
M00535130	08714729146575	Stonetome Device (above cut wire)	11.5	200	20	30	5.5	.035	Each

Active Cords sold separately [▶](#) (See page 12).

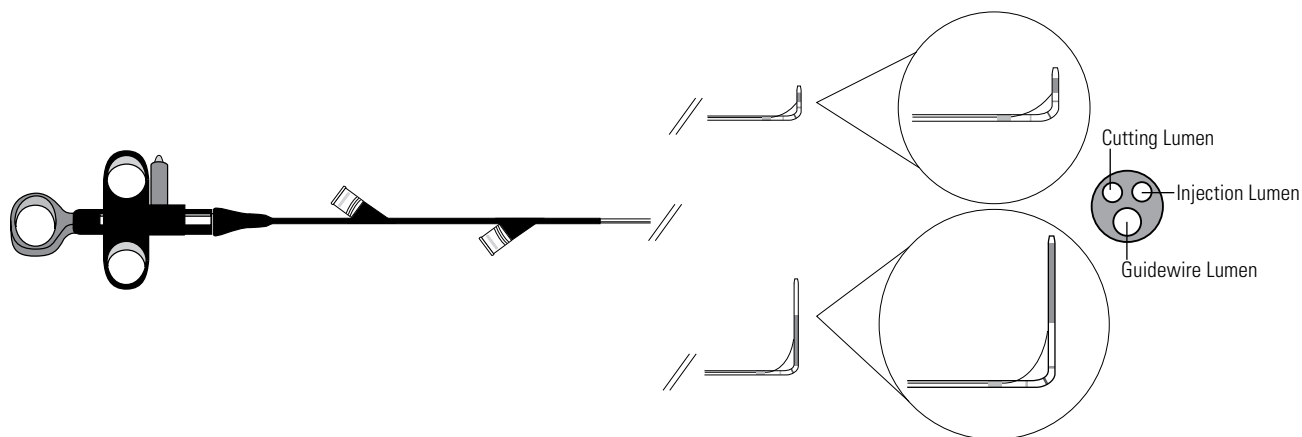

Ultratome™ XL Triple-Lumen Sphincterotome



Order Number	GTIN	Description	Wire Length (mm)	Shaft O.D. (Fr)	Catheter Length (cm)	Tip Length (mm)	Recommended Guidewire (in)	Packaging
M00535900	08714729103257	Ultratome XL Short Nose Sphincterotome	20	5.5	200	5	.035	Each
M00535910	08714729103301	Ultratome XL Long Nose Sphincterotome	20	5.5	200	20	.035	Each
M00535920	08714729103318	Ultratome XL Short Nose Sphincterotome	30	5.5	200	5	.035	Each
M00535930	08714729103349	Ultratome XL Long Nose Sphincterotome	30	5.5	200	20	.035	Each

Active Cords sold separately [▶](#) (See page 12).

Biliary

Sphincterotomes (Continued)

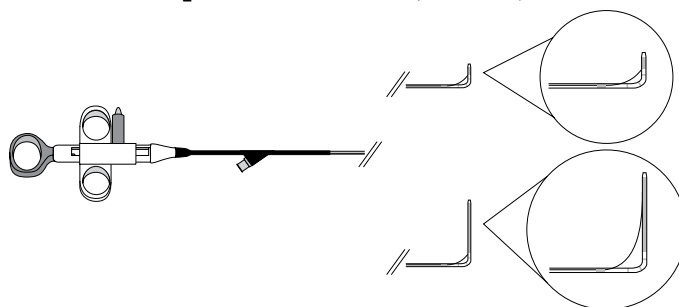

Ultratome™ Double-Lumen Sphincterotome



Order Number	GTIN	Description	Wire Length (mm)	Distal Tip O.D.		Catheter Length (cm)	Tip Length (mm)	Recommended Guidewire (in)	Packaging
				(mm)	(Fr)				
M00530800	08714729163664	Ultratome Short Nose Sphincterotome	20	1.8	5.5	200	5	.035	Each
M00530810	08714729183143	Ultratome Long Nose Sphincterotome	20	1.8	5.5	200	20	.035	Each
M00530820	08714729193418	Ultratome Short Nose Sphincterotome	30	1.8	5.5	200	5	.035	Each
M00530830	08714729193425	Ultratome Long Nose Sphincterotome	30	1.8	5.5	200	20	.035	Each

Active Cords sold separately (See page 12).

RX Cannulas

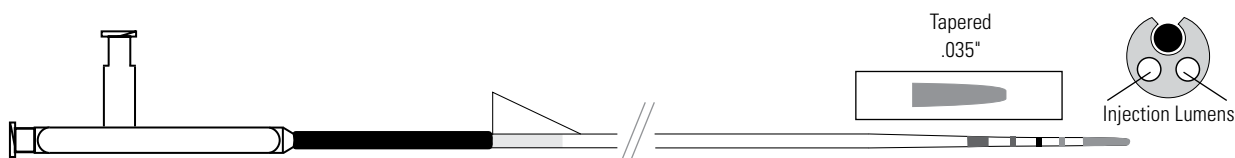

Rapid Exchange XL Cannula



Order Number	GTIN	Description	Working Length (cm)	Tip Style	Recommended Guidewire (in)	Packaging
M00545820	08714729301905	Rapid Exchange XL Cannula	195	Tapered	.035	Each

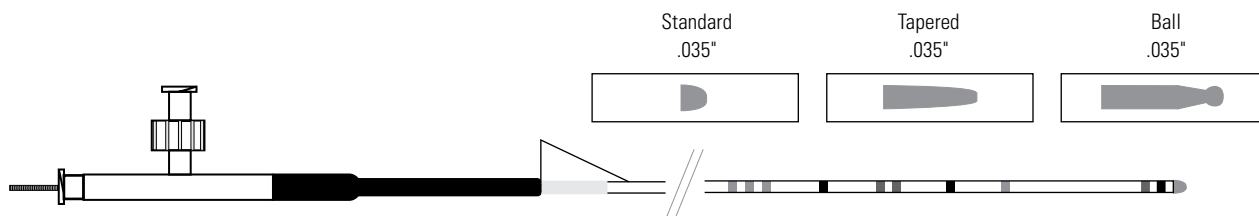

RX ERCP Cannulas



Order Number	GTIN	Description	Working Length (cm)	Recommended Guidewire (in)	Packaging
M00545760	08714729268642	RX ERCP Cannula Standard Tip	210	.035	Each
M00545770	08714729268659	RX ERCP Cannula Tapered Tip	210	.035	Each
M00545780	08714729268673	RX ERCP Cannula Ball Tip	210	.035	Each



Section Table of Contents

Prev Page 10 Next Page

Main Table of Contents



Biliary

Cannulas

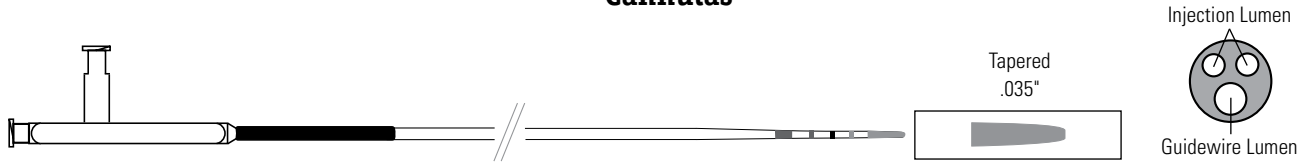

Tandem™ XL Triple-Lumen ERCP Cannula



Order Number	GTIN	Distal Tip O.D.		Catheter Size (Fr)	Working Length (cm)	Tip Style	Recommended Guidewire (in)	Packaging
		(Fr)	(mm)					
M00535700	08714729146636	5.5	1.8	7.0 – 5.5	200	Tapered	.035	Each

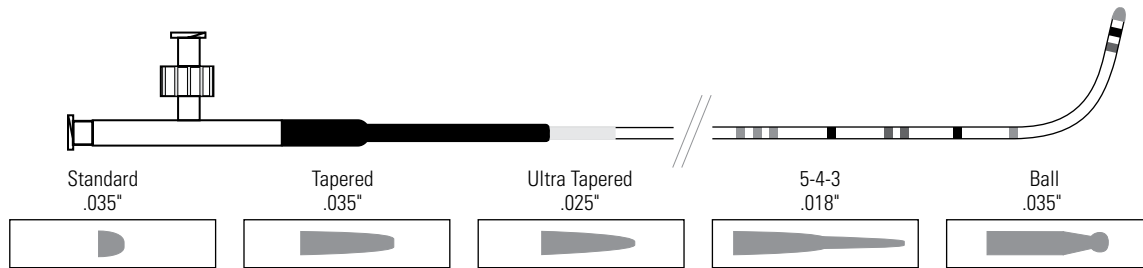

Contour™ ERCP Cannulas



Order Number	GTIN	Description	Distal Tip O.D.		Working Length (cm)	Tip Style	Recommended Guidewire (in)	Packaging
			(Fr)	(mm)				
M00530850	08714729099789	Contour ERCP Cannula	5	1.7	210	Standard	.035	Each
M00530860	08714729099819	Contour ERCP Cannula	5	1.7	210	Tapered	.035	Each
M00530870	08714729099826	Contour ERCP Cannula	5	1.7	210	Ultra Tapered	.025	Each
M00530880	08714729099833	Contour ERCP Cannula	5	1.7	210	5-4-3	.018	Each
M00530890	08714729099840	Contour ERCP Cannula	5	1.7	210	Ball Tip	.035	Each

Biliary

Accessories

RX Locking Devices and Biopsy Cap Systems



Order Number	GTIN	Description	Packaging
M00545471	08714729337768	RX Locking Device (Biopsy Cap not included)	Box 10
M00545211	08714729440604	RX Locking Device Olympus™ / FujiFilm™ Brand Endoscope Compatible	Box 10
M00545261	08714729296614	RX Locking Device and Biopsy Cap System – Olympus / FujiFilm G5 Series Brand Endoscope Compatible	Box 10
M00545271	08714729296621	RX Locking Device and Biopsy Cap System – Pentax™ Brand Endoscope Compatible	Box 10
M00545281	08714729296638	RX Locking Device and Biopsy Cap System – FujiFilm Type 3 Series Brand Endoscope Compatible	Box 10

Active Cords (Fit Boston Scientific Endoscopy Sphincterotome)

Order Number	Description	Packaging
M00561250	Active Cord, Fits Olympus Brand Generator	Each
M00561270	Active Cord, Fits Endostat™, Endostat II and Endostat III Generators, Bovie™, Valleylab™, Aspen Labs™, and ERBE™ Brand Generators	Each

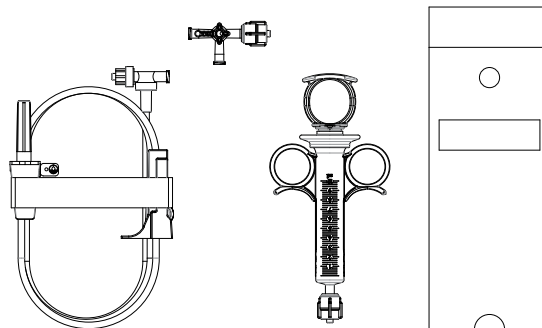

Rapid Refill Continuous Injection System



Order Number	GTIN	Description	Packaging
M00566001	08714729285151	Rapid Refill Continuous Injection System	Box 10